

DESCRIPTION/TITLE						
機器外観図						
MODEL/USER						
ClearOne CONVERGE590 Wired						
DRAWING No.						
sk060613-02						
REVISION						
DISK/FILE	APPROVED	CHECKED	DRAWN	DESIGNED	SCALE	SHEET
			S.K		1/2	

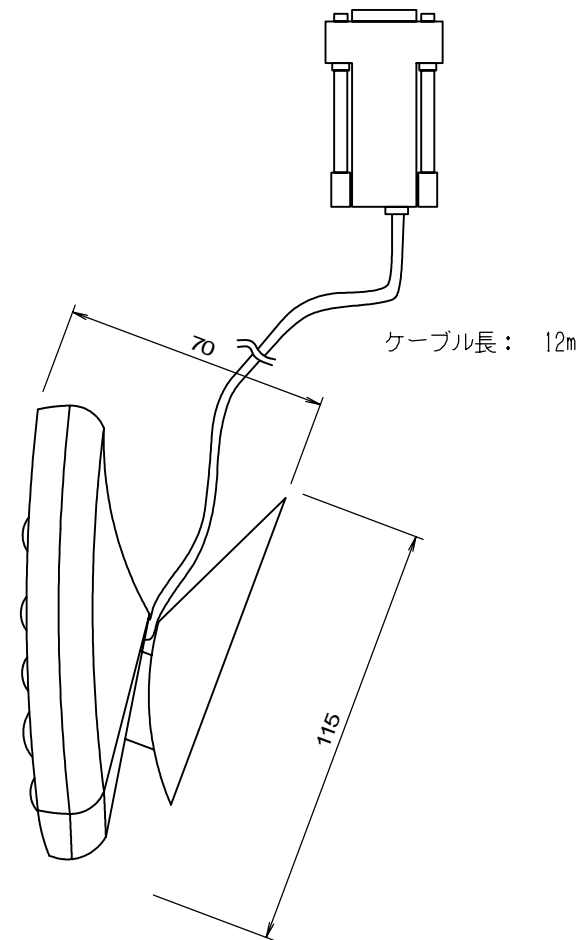

DESCRIPTION/TITLE						
機器外觀図						
MODEL/USER						
ClearOne Converge Wired Controller						
DRAWING No.						
sk060613-03						
REVISION						
DISK/FILE	APPROVED	CHECKED	DRAWN	DESIGNED	SCALE	SHEET
			S.K		1/2	

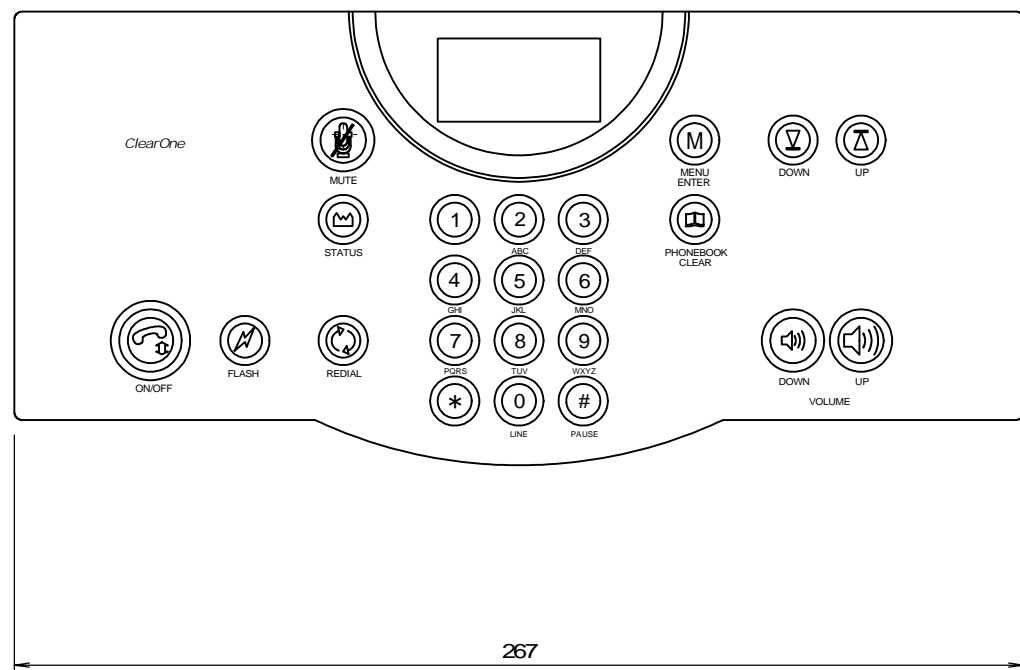
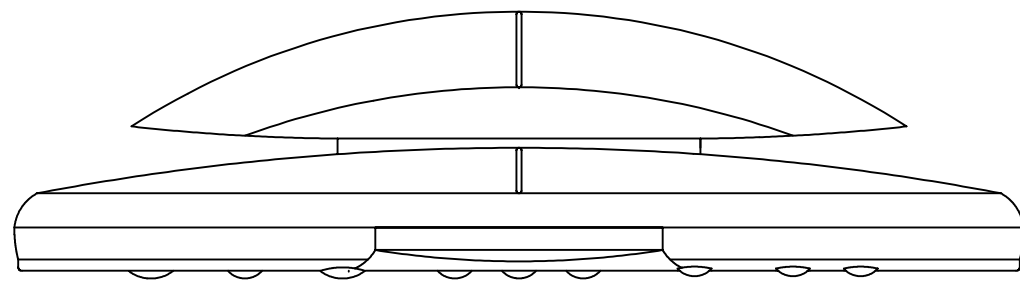
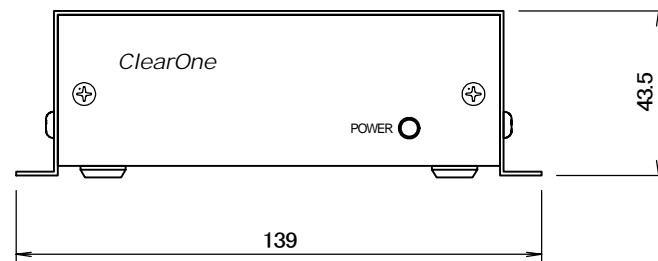
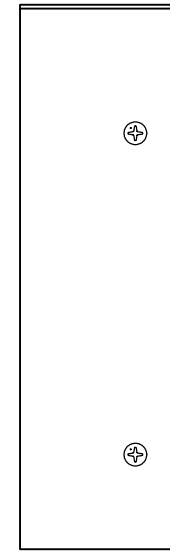
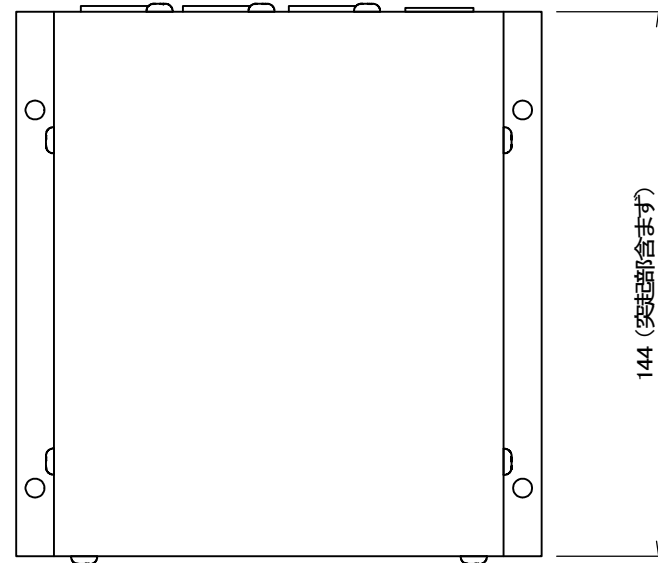
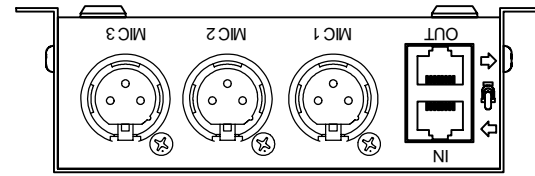

DESCRIPTION/TITLE						
機器外形図						
MODEL/USER						
CONVERGE MIC Distribution Box						
DRAWING No.						
sk060613-01						
REVISION						
DISK/FILE	APPROVED	CHECKED	DRAWN	DESIGNED	SCALE	SHEET
			S.K		1/2	